



CROSSHELMET

USER GUIDE

USER GUIDE

Content/ Quick Start	5	Limitation of Liability	18
Features	7	Battery Safety Precautions	19
Initial Set-Up	9	Correct Disposal	19
Head-Up Display	11	Modifications	19
Sound, Camera, Lights	13	FCC Compliance	20
Touch Panel, Connectivity	15	IC Warning	21
Touch Gestures	16	ECE Warning	23
Security Information	17	Further Regulations	24
Limited Warranty Notice	17	Tech Specs	27

CONTENTS OF THE PACKAGING



1 HELMET

2 USB CABLE

3 ADAPTER

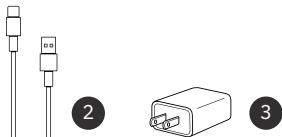

QUICK START

1. POWER ON

Turn on the helmet on the power button.

2. CONNECT

Turn on bluetooth and connect the helmet with your mobile device.

3. APP LAUNCH

Launch the app and configure your personal settings

4. GO RIDE

Experience the CrossHelmet with all it's functions on it's first ride.

CROSSHELMET X1 FEATURES

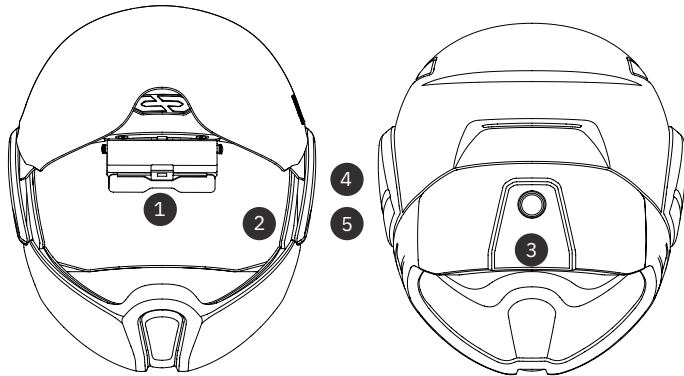

- 1 HEAD-UP DISPLAY
- 2 SOUND CONTROL
- 3 REAR-VIEW CAMERA
- 4 SAFETY LIGHT
- 5 TOUCH PANEL
- 6 CONNECTIVITY

INITIAL SET-UP

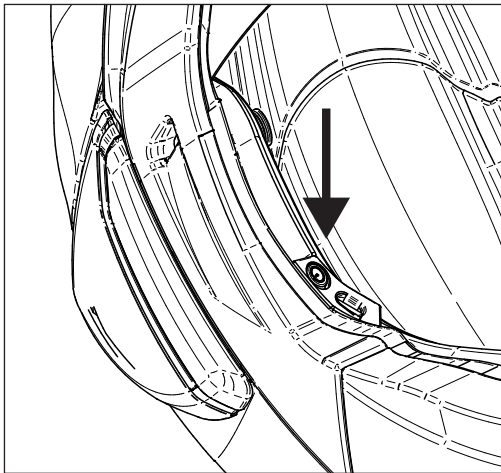

1 POWER ON

Press the power button 5 sec. The LED on the sides of the helmet light up when the helmet turns on.

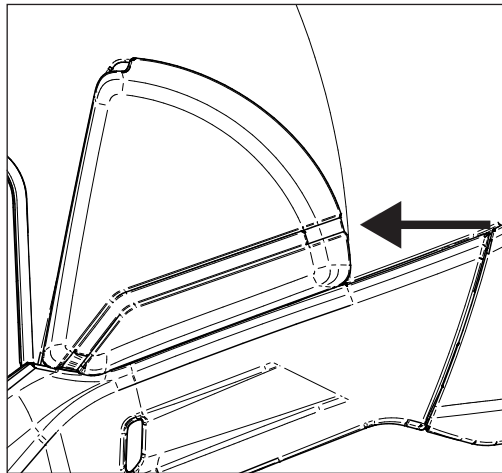

2 LED ON

Press the power button 5 sec. The LED on the sides of the helmet light up when the helmet turns on.

3 HUD ADJUSTMENT

Adjust the HUD into the correct personal angle. The display should not overlap your vision.

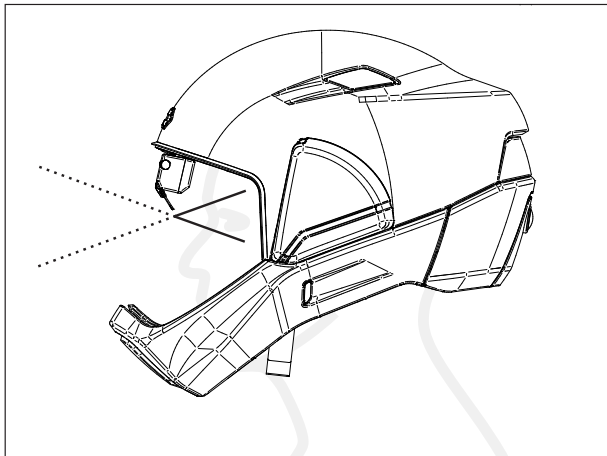

4 HUD ACTIVATION

Await HUD activation (25 to 30 sec).

5 HUD ADJUSTMENT

Adjust the HUD unit and rotate to preferred position.

Use the dials to adjust the HUD to personal preference and best visibility. The left and right dials control the display image respectively. When turning clockwise the image moves left and when turning counter-clockwise the image moves right.

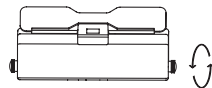

ADJUSTMENT: Clockwise -> left; Counter-clockwise -> right

MIRROR LENSE CLEANING ADVISE:

The outer mirror face has a special coating and care should be taken during cleaning. Use of paper cleaning wipes is recommended to avoid scratches to coating.

Step 1: Use air blower to blow away any specks of dust or dirt.

Step 2: Using paper wipes, gently wipe mirror lens in circular motion.

6 SOUND SETTING

The CrossHelmet has 2 volume controls.

1. Smartphone volume
2. CrossHelmet system volume

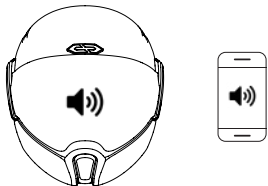

Please set up Bluetooth pairing with your phone and CrossHelmet X1 and set maximum volume.

SOUND CONTROL

Customize SoundControl with the sliders in the CrossHelmet Application and adjust every value to your preference.



VOLUME

Swipe upwards to tune up and downwards to tune down.

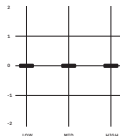

7 REAR-VIEW CAMERA

The rear-view is projected onto the HUD.
For best image quality and vision adjust the HUD according to personal preference.

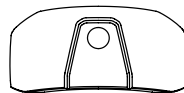

8 SAFETY LIGHTS

The safety lights are located underneath the Touch Panel as well as on the opposite side, increasing visibility of the rider at night adding to overall safety.

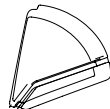

9 REARVIEW RECORDING

If your helmet includes the recording upgrade, please follow these steps to record.

1. Pair your X1 with your smartphone.
2. In the CrossHelmet application, open the settings and tap "Rearview Recording"
3. Tap "Start" and "Stop" to manage your recordings.
4. Restart your X1 and connect to your PC via USB-C.
5. Video files will be accessible in your CrossHelmet drive directory.

5 TOUCH PANEL

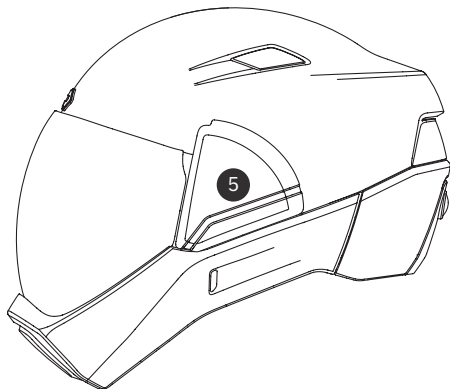

6 CONNECTIVITY

Connect your phone with the CrossHelmet.

TOUCH GESTURES



PLAY/PAUSE

Tap to play or pause your music player.



SKIP SONG

Swipe forwards to skip the currently playing song.



VOLUME UP

Swipe upward to turn up the volume.



TAKE CALL

Tap to take a call or end a call.



REWIND

Swipe backwards to go back to the previous song.



VOLUME DOWN

Swipe downward to turn down the volume.

SECURITY INFORMATION

- Do not disassemble, open, drop (mechanical abuse), crush, bend, deform, puncture, or shred.
- Do not modify or remanufacture, attempt to insert foreign objects into the battery, immerse or expose to water or other liquids, or expose to fire or excessive heat including soldering irons, or put into the microwave.
- Only use the battery with the charging system specified by the manufacturer/supplier.
- Do not short-circuit a battery or allow metallic or conductive objects to contact both battery terminals simultaneously.
- Replace the battery only with another battery that has been qualified with same characteristics. Use of an unqualified battery may present a risk of fire, explosion, leakage, or other hazard.
- Dispose of used batteries promptly according to the manufacturer/supplier's instructions.
- Improper battery use may result in a fire, explosion, or other hazard.
- Battery usage by children should be supervised.

LIMITED WARRANTY NOTICE

The CrossHelmet X1 and accessories purchased through our official distribution channels is warranted by Borderless Inc. for a period of two years from date of original purchase in connection with any defects in material and/or workmanship. This warranty shall put a limit to repair of defects in material and/or workmanship. This will be provided under the condition of free charge by the Borderless Inc. However, insurance handling, transportation and other incidental charges in relation to repair work must be borne by the owner. Borderless Inc. will not assume the responsibility for damages or loss encountered in transit. In case the warranty service is needed and the valid claim is received within the Warranty period, purchaser's name, address, serial number and a copy of proof of purchase receipt is required and must be taken or mailed to Borderless. The original receipt is recommended to present the proof of the original purchase. This warranty shall not apply, if the defector or malfunction was caused

by damage resulting any misuses or abuses of the product, improper testing, spillage of foods or liquids, wrong voltage disassembly or from any other operation of the product contrary to instructions contained in the manual. This warranty does not cover any defect that has occurred as a result of any modification or servicing performed by anyone other than the designated Borderless Inc. service. Routine cleaning and normal cosmetic and mechanical wear are not covered under the terms of this warranty. Borderless Inc. shall not be liable for any consequential or incidental damages (such as traffic accidents, data loss) resulting from any breach of warranty, express or implied, applicable to this product. No refunds will be made on repairs performed by un-designated service stations. This warranty is valid for only CrossHelmet X1. This warranty policy does not affect the consumer's statutory rights under the applicable national law in force. Borne by the owner. Borderless Inc. will not assume the responsibility for damages or loss encountered in transit.

LIMITATION OF LIABILITY

Except for the express warranties set forth above, Borderless grants no warranties, express or implied, by status or otherwise, regarding the CrossHelmet X1, fitness for any purpose or otherwise. Consumer law in some countries does not permit limitations under a Product warranty and therefore certain limitations set out in this warranty document not apply. As a consumer your use of the CrossHelmet X1 shall be non-commercial. Borderless shall therefore not be liable for any loss of profit or anticipated savings. In any event, Borderless and its supplier's liability under this limited warranty shall be limited to the amount actually paid by consumer for the Product or the current replacement value, whichever is greater. The Warranty shall not touch the shell replacement program, which allows to renew the helmet's shell for a reduced price. Nothing in this warranty shall exclude or limit Borderless' liability for death or personal injury caused by its negligence, fraud or any other liability that can not be limited or excluded by law. If you CrossHelmet X1 arrives damaged, you must notify Borderless within ten (10) days.

www.crosshelmet.com

BATTERY - SAFETY PRECAUTIONS

Only use the charging unit provided. Never use a damaged charger. Remember to charge the device before storing for a long period of time. Do not leave your device in hot or cold areas (car in direct sunlight or parked in a garage in winter). Always store in area where temperatures remain stable. The charger and the device can become hot during charging. Do not cover. Do not disassemble the device. In the event of battery leakage, avoid contact of the liquid with skin and eyes. If contact occurs, rinse affected areas with plenty of water and contact a physician.

CORRECT DISPOSAL (WASTE ELECTR. + ELECTRONICAL EQUIPMENT)

The trash mark shown on the product or its literature indicates that it should not be disposed with other household wastes at the end of its working life. To prevent possible harm to the environment or human health from uncontrolled waste disposal, please separate this from other types of wastes and recycle it responsibly. Reset to promote the sustainable reuse of material resources. Household users should contact either the retailer where they purchased this product, or their local government office for details of where and how they can take this item for environmentally safe recycling. Business users should contract their supplier and the terms and conditions of the purchase contract. This product should not be mixed with other commercial wastes for disposal.

MODIFICATIONS

The explanations and specifications in this guide are given for information purposes only and may be modified without prior notice. They are deemed to be correct at the time of going to press. The utmost care has been taken when writing this guide as part of the aim to provide you with accurate information. However, CrossHelmet shall not be held responsible for any consequences arising from any errors or omissions in the guide, not for any damage or accidental loss of data resulting directly or indirectly from the use of the information herein. Cross-

Helmet reserves the right to amend and improve the product design or user guide without any restrictions and without any obligation to notify users. If so, a later version of this guide might be available in electronic format at www.crosshelmet.com.

FEDERAL COMMUNICATIONS COMMISSION STATEMENT

This device complies with FCC Rules Part 15.

Operation is subject to the following two conditions:

- This device may not cause harmful interference.
- This device must accept any interference received, including interference that may cause undesired operation.

This equipment has been tested and found to comply with the limits for a class B digital device, pursuant to Part 15 of the Federal Communications Commission (FCC) rules.

These limits are designed to provide reasonable protection against harmful interference in a residential installation. This equipment generates, uses, and can radiate radio frequency energy and, if not installed and used in accordance with the instructions, may cause harmful interference to radio communications. However, there is no guarantee that interference will not occur in a particular installation. If this equipment causes harmful interference to radio or television reception, which can be determined by turning the equipment off and on, the user is encouraged to try to correct the interference by doing one or more of the following measures:

- Reorient or relocate the receiving antenna.
 - Increase the separation between the equipment and receiver.
 - Connect the equipment into an outlet on a circuit different from that to which the receiver is connected.
 - Consult the dealer or an experienced radio/TV technician for help.
- FCC Caution Any changes or modifications not expressly approved by the party

responsible for compliance could void the user's authority to operate the equipment. The antenna(s) used for this transmitter must not be co-located or operating in conjunction with any other antenna or transmitter. Radiation Exposure Statement: This equipment complies with FCC radiation exposure limits set forth for an uncontrolled environment. End users must follow the specific operating instructions for satisfying RF exposure compliance. This transmitter must not be co-located or operating in conjunction with any other antenna or transmitter. To maintain compliance with FCC exposure compliance requirement, please follow operation instruction as documented in this manual.

The FCC ID is displayed on the bottom left of the Head-Up Display of the CrossHelmet.

FCC ID 2AUQACRSX1V001

IC WARNING

Canada, Industry Canada (IC) Notices

This Class B digital apparatus complies with Canadian ICES-003 and RSS-210.

Operation is subject to the following two conditions: (1) this device may not cause interference, and (2) this device must accept any interference, including interference that may cause undesired operation of the device. The IC ID for this device is 3568A-K00A.

Radio Frequency (RF) Exposure Information

The radiated output power of the Wireless Device is below the Industry Canada (IC) radio frequency exposure limits. The Wireless Device should be used in such a manner such that the potential for human contact during normal operation is minimized.

This device has been evaluated for and shown compliant with the IC Specific Absorption Rate ("SAR") limits when installed in specific host products operated in portable exposure conditions.

Canada's REL (Radio Equipment List) can be found at the following web address:

<http://www.ic.gc.ca/app/sitt/reltel/srch/nwRdSrch.do?lang=eng>

Additional Canadian information on RF exposure also can be found at the following web address:

<http://www.ic.gc.ca/eic/site/smt-gst.nsf/eng/sf08792.html>

Canada, avis d'Industrie Canada (IC)

Cet appareil numérique de classe B est conforme aux normes canadiennes ICES-003 et RSS-210.

Son fonctionnement est soumis aux deux conditions suivantes: (1) cet appareil ne doit pas causer d'interférence et (2) cet appareil doit accepter toute interférence, notamment les interférences qui peuvent affecter son fonctionnement.

L'identifiant IC de cet appareil est 3568A-K00A.

Informations concernant l'exposition aux fréquences radio (RF)

La puissance de sortie émise par cet appareil sans fil est inférieure à la limite d'exposition aux fréquences radio d'Industrie Canada (IC). Utilisez l'appareil sans fil de façon à minimiser les contacts humains lors du fonctionnement normal.

Ce périphérique a été évalué et démontré conforme aux limites SAR (Specific Absorption Rate – Taux d'absorption spécifique) d'IC lorsqu'il est installé dans des produits hôtes particuliers qui fonctionnent dans des conditions d'exposition à des appareils portables.

Ce périphérique est homologué pour l'utilisation au Canada. Pour consulter l'entrée correspondant à l'appareil dans la liste d'équipement radio (REL - Radio Equipment List) d'Industrie Canada rendez-vous sur:

<http://www.ic.gc.ca/app/sitt/reltel/srch/nwRdSrch.do?lang=eng>

Pour des informations supplémentaires concernant l'exposition aux RF au Canada rendez-vous sur :

<http://www.ic.gc.ca/eic/site/smt-gst.nsf/eng/sf08792.html>

IC Warning Statement

The device could automatically discontinue transmission in case of absence of information to transmit, or operational failure. Note that this is not intended to prohibit transmission of control or signaling information or the use of repetitive codes where required by the technology.

The Country Code Selection feature is disabled for products marketed in the US/Canada. For product available in the USA/Canada markets, only channel 1-11 can be operated. Selection of other channels is not possible.

ECE WARNING

For adequate protection, this helmet must fit closely and be securely attached. Any helmet that has sustained a violent impact should be replaced and, if fitted with a non protective lower face cover: “Does not protect chin from impacts” together with the symbol indicating the unsuitability of the lower face cover to offer any protection against impacts to the chin.

Every protective helmet shall be clearly marked with its size and its maximum weight, to the nearest 50 grammes, as placed on the market. The maximum weight quoted should include all the accessories that are supplied with the helmets, within the packaging, as it is placed on the market, whether or not those accessories have actually been fitted to the helmet.

FURTHER REGULATIONS

CE:

CE User manual requirement: Adding product specification (Frequency range, output power, antenna info...)

ISED (Canada):

[English]

This device complies with Innovation, Science and Economic Development Canada's licence-exempt RSSs. Operation is subject to the following two conditions:

- (1) This device may not cause interference; and
- (2) This device must accept any interference, including interference that may cause undesired operation of the device.

Cet appareil est conforme aux flux RSS exemptés de licence d'Innovation, Science et Développement économique Canada. L'opération est soumise aux deux conditions suivantes:

- (1) Cet appareil ne doit pas provoquer d'interférence; et
- (2) Cet appareil doit accepter toute interférence, y compris les interférences susceptibles de provoquer un fonctionnement indésirable de l'appareil.

ISED Radiation Exposure Statement

[English] Radiation Exposure Statement: This equipment complies with the IC RSS-102 radiation exposure limits set forth for an uncontrolled environment. This equipment should be installed and operated with a minimum distance of 20 cm between the radiator and your body.

[French] Énoncé d'exposition aux rayonnements: Cet équipement est conforme aux limites d'exposition aux rayonnements ioniques RSS-102 Pour un environnement incontrôlé. Cet équipement doit être installé et utilisé avec un Distance minimale de 20 cm entre le radiateur et votre corps.

RF Exposure warning statements:

This equipment complies with FCC radiation exposure limits set forth for an uncontrolled environment. End users must follow the specific operating instructions for satisfying RF exposure compliance. This transmitter must be at least 20 cm from the user and must not be co-located or operating in conjunction with any other antenna or transmitter.

TECH SPECS

Model name	X1 - Cross One
Safety certifications	DOT, ECE, JIS
Shell material	Polycarbonate +ABS
Weight	1,965g
Main processor	Quad ARM Cortex A53, 1.2 GHz
Flash storage	8GB
Mobile application	iOS, Android
Operational Frequency Range	2.4 GHz transceiver
Antenna information	1x antenna at 2.5 dBi gain
Usage environment	Outdoor
Frequency channel bandwidth	Bandwidth period 0.5
Modulation	GFSK modulation

Radio used	WCN3620 chipset
Output Power	100 mW output power (WCN3620 Class 1)
Inputs	USB type-C
HUD	0.23 nHD+ resolution (3281 ppi)
Camera angle	170 degrees
LED safety light	White
Operational time	6-8 hours
Sizing	Medium (58-60cm), Large (61-63cm)
Color	Luster Black
Visor	Clear, Tinted, Photochromic